

Windows

inspired by you.





Contents

- 5 CHOOSING A WINDOW
- 6 NEW COMFORT AND DESIGN ADVANCED SLIDER
- 19 PATIO DOORS
- 27 SELECT YOUR GLASS
- 28 ACCESSORIES
- 30 HARDWARE



Which window is right for you?

That depends on the style of your home, the size of your budget and your own preferences. With Ply Gem, you can choose from a wide range of styles to meet your needs. To help stretch your budget while maintaining a consistent look, consider upgrading the windows in the front and choose less costly windows in the back that are identical on the interior. If you're looking for more colourful options, our Fusion Colour Wrap™ series or aluminum clad windows offer a wide spectrum of choices. Whatever inspires you, look to Ply Gem for solutions custom made for you.

4 steps to your new windows.

Choosing new windows doesn't have to be complicated. Budget and colour will influence your choice of vinyl or clad windows. The design of your home will help determine the style you select. Light and climate conditions will help you choose the best glass option. After that, you can customize the look with grilles and hardware.



1

Choose **frame material**.

- ▶ **Vinyl** – Our Comfort and Vista windows offer great value, energy efficiency and a lifetime of low-maintenance beauty.
- ▶ **Clad Vinyl** – Our Design Series, offers the beauty of aluminum on the outside with the energy efficiency and low maintenance of vinyl on the inside. Design Architectural Series offers an exterior & interior aluminum frame perfectly suited for today's modern style homes.
- ▶ **Clad Wood** – Signature Series windows offer the natural beauty of wood on the inside and colourful, durable aluminum cladding on the outside.

2

Select **your style**.

Choose from six different styles: single hung, sliding, casement, awning, fixed and picture windows. Combinations with or without architectural shapes are also available. For an explanation of window styles, [see page 18](#).

3

Get the **right glass for you**.

We offer several glass options to meet specific climate conditions. Choices include double - or triple-glazing tailored to your needs with LoE coatings and argon gas fill. In addition, we offer glass options for safety, privacy and sound control. [See page 24 for details](#).

4

Add the **finishing touches**.

Grilles can turn a plain window into a stylish statement. Hardware finishes and trim options also play a part in your window's aesthetics. [Explore your options on page 28](#).

New Advanced Slider

The new Comfort Advanced Slider and Design Advanced Slider are Ply Gem's highest performing slider to date. Offered in dual and triple glazing, these windows will offer all the options and accessories already available with the Comfort and Design series with enhanced performance features.

Comfort Advanced Slider



Product Options

- ▶ Fusion Colour Wrap™ for exterior and interior application.
- ▶ Ability to include grilles and simulated divided lites.
- ▶ Largest slider frame size available for unobstructed views.
- ▶ Dual and triple glazed options available.

Performance

- ▶ Water penetration resistance rated to 400 Pa.
- ▶ Air Infiltration rates as A3 for horizontal slider and A2 for vertical slider.
- ▶ Meets prescriptive energy efficiency requirements for BC markets with triple glazed windows with one coating of Exo Max Shield 366.

U-Values

Profile	Highest TG 2: LoE 270/Arg/Clear/Arg/LoE 180		Lowest DG: Clear/Air/LoE 180	
	Metric	Imperial	Metric	Imperial
	Comfort Advanced Vertical Slider	0.97	0.17	1.82
Comfort Advanced Horizontal Slider	0.97	0.17	1.82	0.32
Comfort Advanced Direct Set (Slider)	0.85	0.15	1.76	0.31

Design Advanced Slider



Product Options

- ▶ Aluminum clad exterior options.
- ▶ Fusion Colour Wrap™ for interior application.
- ▶ Ability to include grilles and simulated divided lites.
- ▶ Largest slider frame size available for unobstructed views.
- ▶ Dual and triple glazed options available.
- ▶ Aluminum Clad metal sash for uniform look from the exterior.

Performance

- ▶ Amazing product option for projects working toward net zero or passive house.
- ▶ Water Penetration resistance rated 400 Pa.
- ▶ Air Infiltration rates as A3 for horizontal slider and A2 for vertical slider.

U-Values

Profile	Highest TG 2: LoE 270/Arg/Clear/Arg/LoE 180		Lowest DG: Clear/Air/LoE 180	
	Metric	Imperial	Metric	Imperial
	Design Advanced Vertical Slider	1.02	0.18	1.87
Design Advanced Horizontal Slider	1.02	0.18	1.82	0.32
Design Advanced Direct Set (Slider)	0.85	0.15	1.76	0.31



Features & Benefits

- ▶ Multi-layered film is applied to vinyl using polyurethane reactive hot melt to create permanent bond between wrap and vinyl.
- ▶ Easily withstands the most extreme heat and cold conditions.
- ▶ Extremely resistant to scratches and abrasions.
- ▶ Unaffected by environmental pollutants.
- ▶ Performs well in sea-side applications.
- ▶ Dirt and grime are easily cleaned away using normal mild household cleaners.
- ▶ Available on all our vinyl product lines and for interior application on our Design Series products.

FUSION
COLOUR WRAP™

A cost effective solution to add colour to the interior and exterior of vinyl windows and sliding patio doors.

Structure of the exterior film Renolit Exofol FX



Frame Colour

Interior/Exterior



Interior



Colours are reproduced as accurately as printer technology allows.

Brickmould

2" Renovation brickmould with subsill featuring removable cap to allow installation without disturbing exterior finishes.

Available on four sides or with subsill.

Rebate flush frame option is ideal for replacing aluminum sliders.



2" Brickmould with subsill

Simulated Divided Lites (SDL)

Interior and exterior colours are matched to window or patio door.



1" SDL

2" SML

Vista Series

VINYL WINDOWS



Slimline design. **Expanded view.**

A clean, modern profile. Sturdy, steel-reinforced construction. A contemporary look built to last. Our Vista Series vinyl windows enhance any home at a price that fits any budget.





Standard Features

► Seals out the elements

Tri-Fin weatherstripping prevents drafts, dust and moisture from getting in.

► Smooth operation

Spring balance system makes opening and closing single-hung windows easy; holds sash open at any height.

► Built-in security

Anti-lift sash on sliding windows prevents forced entry.

MATCHING PATIO DOOR

Our Comfort Series patio door pairs well with all our vinyl windows.



Frame Colours

Exterior/Interior



White

Colours are reproduced as accurately as printer technology allows.



Steel-reinforced interlocking sashes increase structural integrity.



Low-friction nylon rollers ensure smooth, effortless operation.



Comfort Series

VINYL WINDOWS



Triple-glazed for **total comfort.**

With sashes that accept full-size triple-glazed units, Comfort Series windows help keep your home cozy even in Arctic conditions. They're ideal wherever comfort and energy savings are paramount.





Standard Features

► Seals out the elements

Tri-Fin weatherstripping prevents drafts, dust and moisture from getting in.

► Sturdy construction

Steel-reinforced interlocking sashes increase structural integrity, water resistance and wind load.

► Smooth operation

Two sets of tandem rollers distribute weight of triple glazing to ensure sliding windows glide easily.

MATCHING PATIO DOOR

Our Comfort Series patio door pairs well with all our vinyl windows.

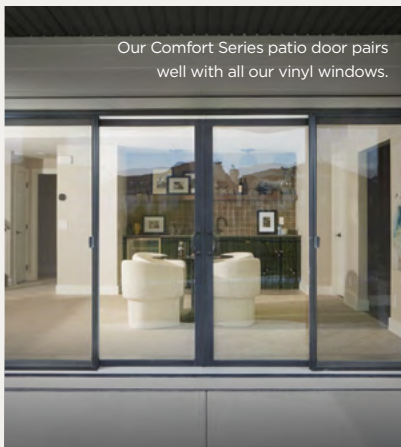

Frame Colours

Exterior/Interior

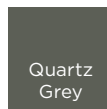
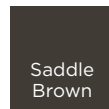
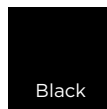
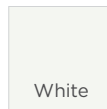

Interior

Colours are reproduced as accurately as printer technology allows.

Hardware Colours



Hardware available in Classic or Contemporary Style. See page 30 for details.

Comfort Advanced Slider

With the new Comfort Advanced Slider, this triple glazed slider can meet the most rigorous performance standards in Canada while also offering all Fusion Colour Wrap™ laminate offerings.

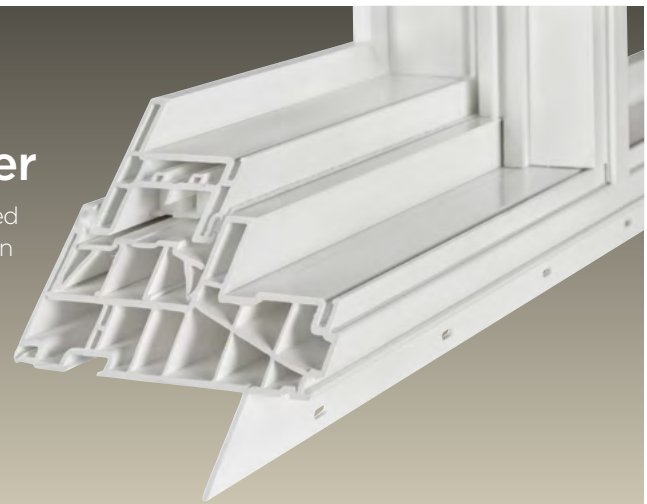

Common Frame Construction

Comfort windows have a common frame. Multi-lite windows feature a continuous head and sill design that provides a clean appearance and eliminates the need for mulls, which are susceptible to air and water penetration.



Design Series

ALUMINUM-CLAD VINYL WINDOWS



Make a **bold statement.**

Our aluminum-clad vinyl windows offer the best of both worlds: durable, colourful exteriors and low maintenance Fusion Colour Wrapped™ vinyl interior. They pair well with our Design Series Patio Doors for a seamless look for your home.





Standard Features

► Seals out the elements

Tri-Fin weatherstripping prevents drafts, dust and moisture from getting in.

► Smooth operation

Spring balance system makes opening and closing single-hung windows easy; holds sash open at any height and wind load.

► Energy-saving glass

Design Series windows are available with double and triple-glazing. Insulated glass units with LoE and argon can be tailored to your requirements.

► Mbar Addition

Mullion or MBar profile in direct set and casement windows provides stronger frames and common frame configurations.

MATCHING PATIO DOOR

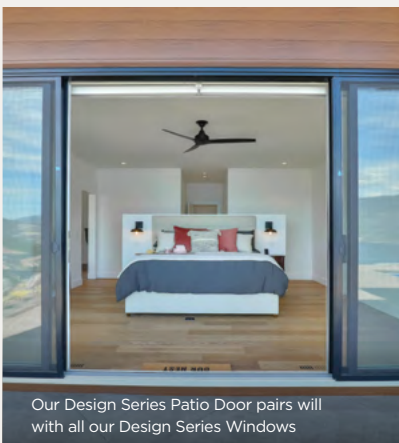

Our Design Series Patio Door pairs will with all our Design Series Windows

Hardware Colours



Hardware available in Classic or Contemporary Style. See page 30 for details

Exterior Frame Colours

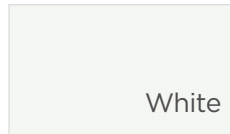

White



Beige

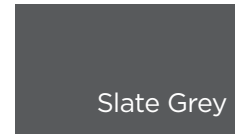

Slate Grey

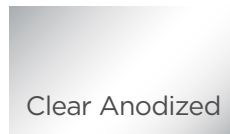

Clear Anodized

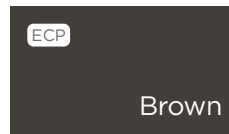

Brown

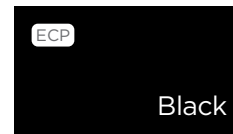

Black

ECP ENHANCED COLOUR PROTECTION

An innovative PVDF coating helps protect our darker colours from fading and chalking. Colours are reproduced as accurately as printer technology allows.

Interior Frame Colours*

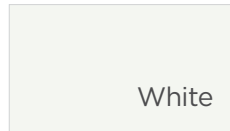

White

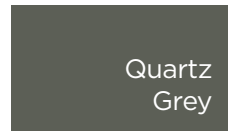

Quartz Grey

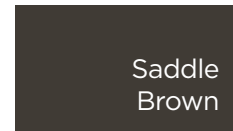

Saddle Brown



Paintable-Stainable

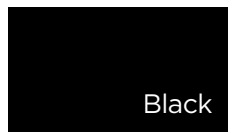

Black

FUSION
COLOUR WRAP™

Design Advanced Slider

The new Design Advanced slider can accommodate frames up to 6 feet, so you never have to compromise your vision.



Stile and rail design for a bold and modern look.



Design Architectural Series

ALUMINUM-CLAD VINYL WINDOWS



Modern innovation.

The Design Architectural Series window offers an exterior and interior extruded aluminum frame that allow for durable colour options perfectly suited for today's modern style homes and buildings.

Design Architectural Series

ALUMINUM-CLAD WINDOWS



Interior Frame Colour

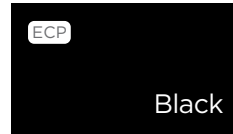

ECP ENHANCED COLOUR PROTECTION

An innovative PVDF coating helps protect our darker colours from fading and chalking. Colours are reproduced as accurately as printer technology allows.

Exterior Frame Colours

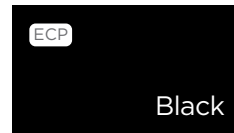
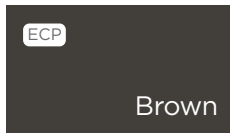
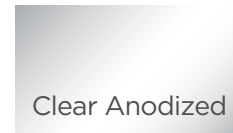
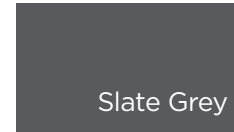
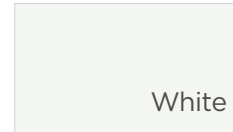

Standard Features

► Fully extruded aluminum

Fully extruded aluminum components provide long lasting strength and beauty.

► Energy efficiency

Vinyl Performance Core provides superior energy efficiency over traditional thermally broken products.

► Structural mullions and continuous frames

Steel reinforced mullions provides structural integrity and continuous nailing fin and frame ensure a water tight frame.

MATCHING PATIO DOOR



Our Design Architectural Series Patio Door pairs will with our Design Architectural Series Windows

Contemporary Hardware

Proprietary slim style hardware available in black.



Balanced Views

Design Architectural Series windows have balanced sight lines. It simply means the sashes on casement and picture combinations are balanced. Equal lite options are also available with fixed combinations.



Stile and rail design for a bold and modern look.

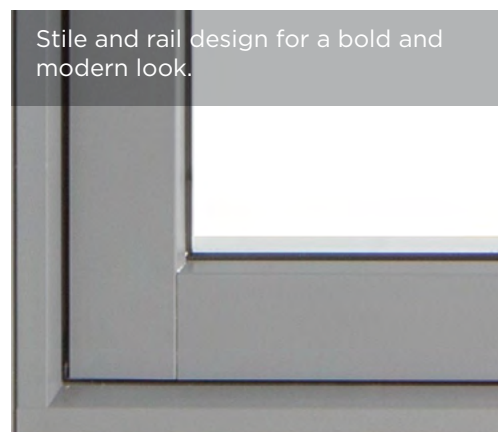

Design Architectural windows are available with your choice of flush interior frame or with built in drywall return receptacle.



Signature Series

ALUMINUM-CLAD WOOD WINDOWS



Traditional craftsmanship.
Enduring beauty.

Signature Series windows are crafted from pine, selected for its strength and extraordinary beauty. The interior can be stained to bring out the fine grain or painted to match your décor. Aluminum cladding protects the exterior from moisture.





Pine interiors can be stained or painted to match your décor.

Standard Features

▶ Aluminum clad exterior

Durable extruded cladding brightens your home with an array of colours.

▶ Weathertight construction

Corner Key joints are sealed to prevent water and air infiltration.

▶ Energy-saving glass

Signature Series windows are available with double- or triple-glazing. Insulated glass units with LoE and argon can be tailored to your needs.

Exterior Frame Colours

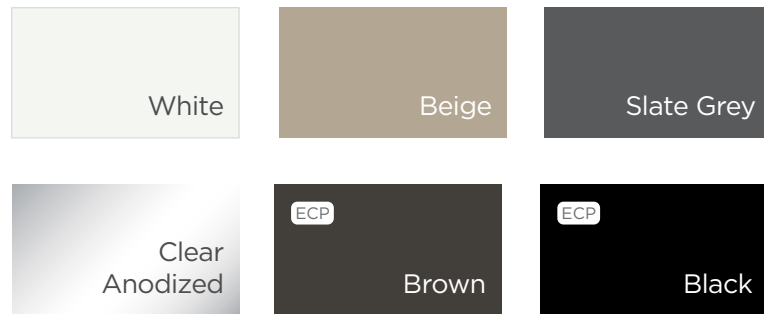

ECP ENHANCED COLOUR PROTECTION

An innovative PVDF coating helps protect our darker colours from fading and chalking. Colours are reproduced as accurately as printer technology allows.

MATCHING PATIO DOOR



Our Signature Series patio door matches Signature Series windows beautifully.

Multi-point lock enhances security and ensures a weather-tight seal.



Sealed mortise and tenon joints are reinforced with corner keys.

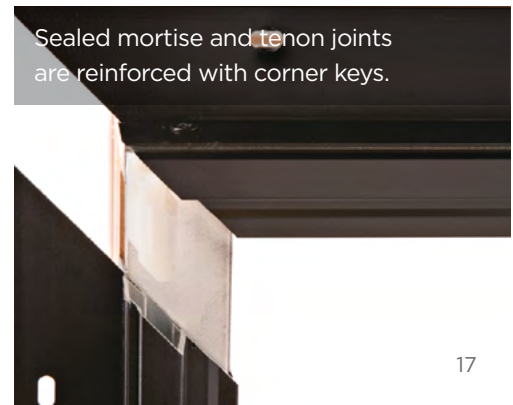

A window for every view.



Single Hung

Single-hung windows have a fixed upper sash and a lower sash that slides vertically to allow ventilation. Popular for traditional homes.



Casement

Casements are hinged on one side and crank open to catch the breeze. They have a contemporary look and are a popular choice over kitchen counters.



Awning

Awning windows are hinged at the top and open outward. Placed high on a wall, they provide light and ventilation while maintaining privacy. Placed below larger fixed windows, they provide ventilation and deflect light rain.



Horizontal Slider

Horizontal sliding windows have one fixed sash and one sash that slides left or right. Popular for modern homes and where you don't want an open sash extending over a deck or patio.



Fixed Pane

Non-operating windows including picture windows and architectural shapes such as half-round, elliptical and trapezoid.



Combinations

Shapes such as arch-top windows can be combined over standard windows to create a distinctive look. Multiple windows can also be combined to create panoramic views and connect a room to the outdoors.

A Door that fits your life.

Sliding Patio Doors

Sliding patio doors are a good choice where floor space is limited. They provide light, expansive views and an easy transition between indoors and out.

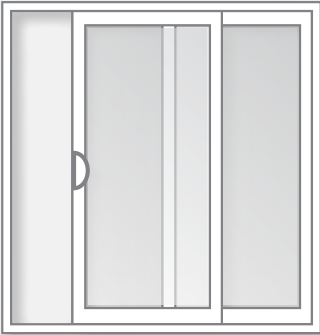

2 Panel - Either panel can be active.

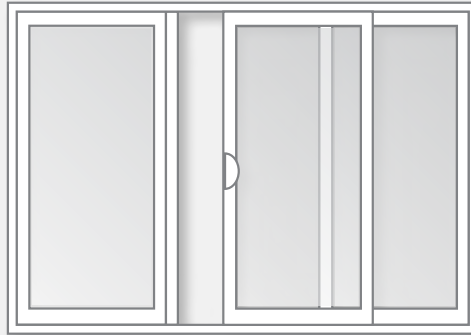

3 Panel Vinyl - Middle panel active for vinyl series.

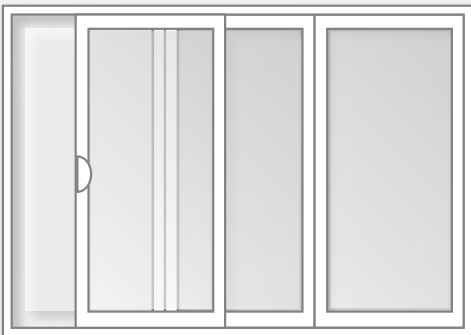

3 Panel - Active outside panel (left or right)

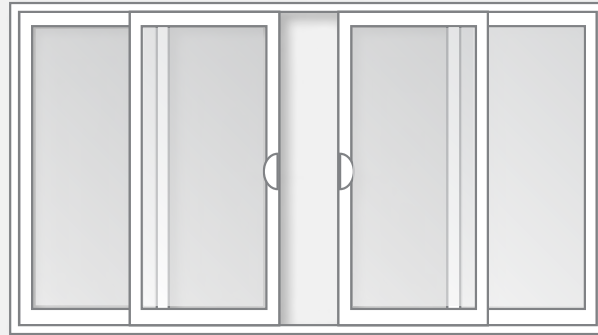

4 Panel - Both center panels are active.

Hinged Patio Doors

Hinged patio doors are either outswing or inswing and create an elegant gateway to the outdoors. Also available as a single panel door.

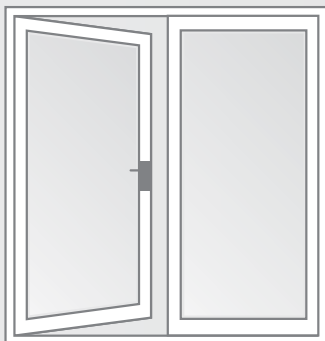

2 Panel Fixed - Either panel can be active, one panel is fixed.

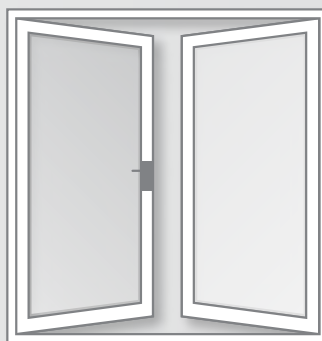

2 Panel Double Door - Both panels can be active.

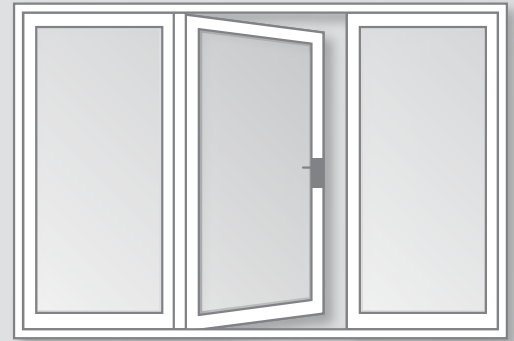

3 Panel - Any of the three panels can be active.

The perfect doors for our windows.



Our sliding patio doors are available in vinyl, clad vinyl and clad wood. (Clad-wood doors are also available as hinged French doors.) Designed to coordinate with our windows, they provide the perfect gateway between your indoor and outdoor living spaces.

Comfort Series

VINYL PATIO DOORS



Like our vinyl windows, our vinyl patio doors are designed to make your home more beautiful and more comfortable.

▶ **Seals out the elements**

Triple weatherstripping prevents drafts, dust and moisture from getting in. The vinyl welded common frame helps prevent air and water penetration.

▶ **Strong and secure**

Interlocking stiles are reinforced with steel.

▶ **Large sizes**

Available in 8-ft. height to accommodate taller ceilings. Wider 16-ft. frames available in 4 - panel units.

▶ **In-Glass Blinds**

An energy-efficient, attractive and easily maintained privacy option.



Hardware Colours

Choose from a variety of standard and designer colours. See page 30 for details

Frame Colours

Exterior/Interior



Interior



Colours are reproduced as accurately as printer technology allows. Toelock is optional for additional security.

Signature Series

WOOD PATIO DOORS

▶ **Beautiful any way you look at it.**

On the outside, durable aluminum cladding is available in an array of colours. On the inside, the fine grain texture of pine can be stained or painted to match your décor.

▶ **Sliding patio door**

Available in wide rail (4-1/2" width stiles and top rail, 7-1/4" width bottom rail).

▶ **Hinged patio door**

Inswing or outswing styles in an elegant wide rail profile (4-1/2" width stiles and top rail, 7-1/4" width bottom rail).

Frame Colours

Exterior



Interior

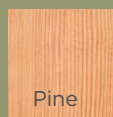

Colours are reproduced as accurately as printer technology allows. Toelock is optional for additional security.



Design Series

CLAD PATIO DOORS

▶ Design Series

On the outside, extruded aluminum cladding ensures lasting beauty. On the inside, high performance vinyl offers a clean, low-maintenance look.

▶ Sturdy construction

Multi-chamber, 100% PVC frame and sash with steel reinforcements ensure lasting beauty.

▶ High efficiency glass

Designed for our northern climate, it increases comfort and lowers energy bills. LoE glazing ensures maximum energy rating.

▶ In-Glass Blinds

An energy-efficient, attractive and easily maintained privacy option.

▶ Seals Out the Elements

Triple weatherstripping prevents drafts, dust and moisture from getting in. The vinyl welded common frame helps prevent air and water penetration.

▶ Strong and Secure

Interlocking stiles are reinforced with steel.



Toe lock is included for added security.



Hardware



See page 30 for details.

Like our vinyl windows, our vinyl patio doors are designed to make your home more beautiful and more comfortable.

Aluminum raised rail protects wheels from damage and jamming from dirt and debris.

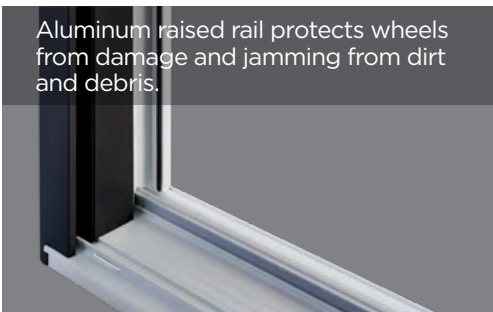

Exterior Colours

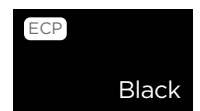
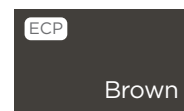
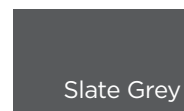
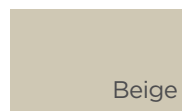
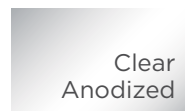

Ultra-durable nylon tandem wheels leave no marks and provide smooth operation.

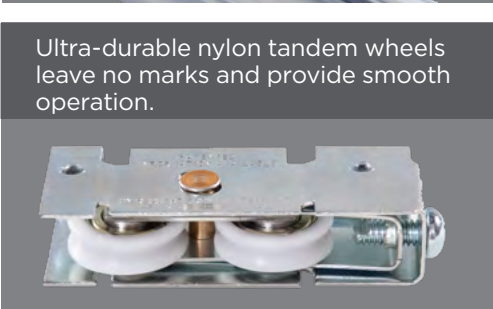

Interior Colours

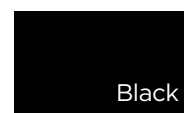
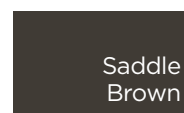
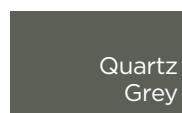
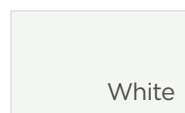

FUSION
COLOUR WRAP™

Colours are reproduced as accurately as printer technology allows.

Design Architectural Series

Exterior Frame Colour

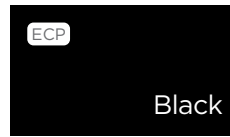
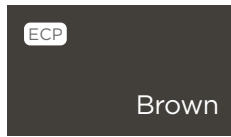
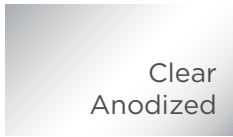

ECP ENHANCED COLOUR PROTECTION

An innovative PVDF coating helps protect our darker colours from fading and chalking. Colours are reproduced as accurately as printer technology allows.

Interior Frame Colour

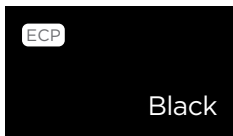

Hardware Options

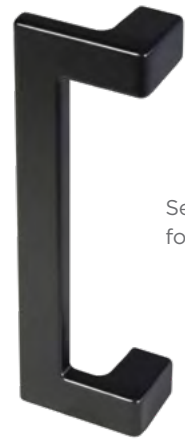

See page 30
for details.



► Design Architectural Series

A modern update on a proven performer. Featuring fully extruded aluminum cladding to both the interior and exterior, this door is perfectly suited for today's modern style homes.

► Beautiful any way you look at it

On the outside, durable aluminum cladding is available in an array of colours. On the inside Black aluminum cladding is offered to provide a clean, modern look for any home or commercial project.

► Sliding patio door

Large sizes available in 8-ft height to accommodate taller ceilings. Wider 16-ft frames available in 4-panel units.

The right glass for you.



Our energy-saving Eco Glass options keep summer heat out and winter heat inside the house. All come with argon gas between the panes to increase insulation values. In addition, different types of LoE coatings are applied to the glass for low, medium or high solar gain.

What is LoE?

Low emissivity (LoE) coatings are applied to glass surfaces to reduce the transfer of heat through the window. High solar gain LoE lets more of the sun's heat pass into a room. Low solar gain Lo blocks more of the sun's heat.

ECO GAIN 180

High Solar Gain Glass

A great choice for our northern climate because it allows solar energy to pass through the glass to provide "free heat" in winter. LoE reflects heat back into the room, reducing home heating needs. Throughout the year, Eco Glass Gain 180 protects furnishings from fading and insulates against extreme temperatures.



Sunny or shady outlook?

South and west-facing windows get the most sunlight. If you want to take advantage of free heat from the sun, consider moderate or high solar gain glass in those locations. If glare is a concern, ask about our tinted glare control glass.

Speak to a Ply Gem associate for more information.

ECO SHIELD 270

Solar Control Glass

A good choice for variable climates. In summer, Eco Glass Shield 270 can reduce solar heat gain by 50% or more compared to ordinary glass. In winter, argon fill and LoE work together to maintain comfort and reduce energy needs. Throughout the year, Eco Glass Shield protects against fading without darkening your view.

ECO MAX SHIELD 366

Ultimate Performance Glass

This "spectrally selective" glass provides the highest level of comfort, energy savings and fade protection. Instead of one or two layers, the glass is coated with three layers of silver to block summer heat and retain your home's heat in winter - with no room-darkening tints and virtually no exterior reflectance.

Custom made for our Canadian climate.

When you live in a country as big as ours, climate conditions vary from wet to dry to extreme hot and cold. So we design our windows to fit the conditions where you live. Our vinyl windows have air pockets inside them that insulate like a parka. Welded corners ensure air and water never get through. Double and triple-glazed glass packages can be tailored to your needs to make your home as cozy and energy efficient as possible.

Triple-glazed comfort.

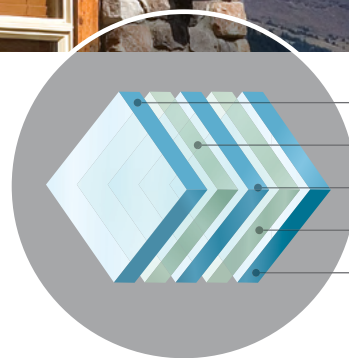

- 1st Pane | LoE Coating
- Argon Gas
- 2nd Pane | Clear
- Argon Gas
- 3rd Pane | Clear

Increase your energy efficiency with a second LoE coat. See page 25.

Our Comfort Series are our most energy-efficient vinyl windows. Designed to accommodate a full-size triple-pane unit, they offer superior insulation values and provide the ultimate in comfort.



Built for **peace of mind.**

One way to recognize a well-made window is to look carefully at the warranty. We offer a Limited Lifetime Warranty on our units. Compare coverage with our competitors and you'll see why Ply Gem is the right choice for your home.

Privacy Glass

Obscure textured glass ensures privacy while allowing sunlight to brighten a room. It's ideal for bathrooms.

Obscure and Tinted Glass

Obscure and tinted glass provides privacy, glare control and a splash of colour.

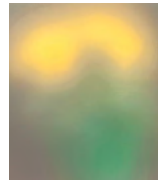

Satin Etch

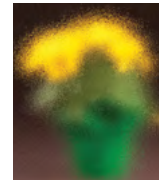

Pinhead



Rain

Protective Film



We help protect our windows and doors during transit and at the job site by applying a clear protective film on inner and outer glass surfaces. It eliminates masking and makes cleanup a snap. Simply peel it off to reveal spotless glass.

NEAT® Glass



This special coating reacts with the sun's rays to loosen dirt so it rinses away when it rains. With NEAT®, your windows will stay cleaner longer and be easier to clean. Available with Eco Shield and Max Shield glass.

Scan for additional information on our Glass Technology



Accessories

Grille Patterns & Colours

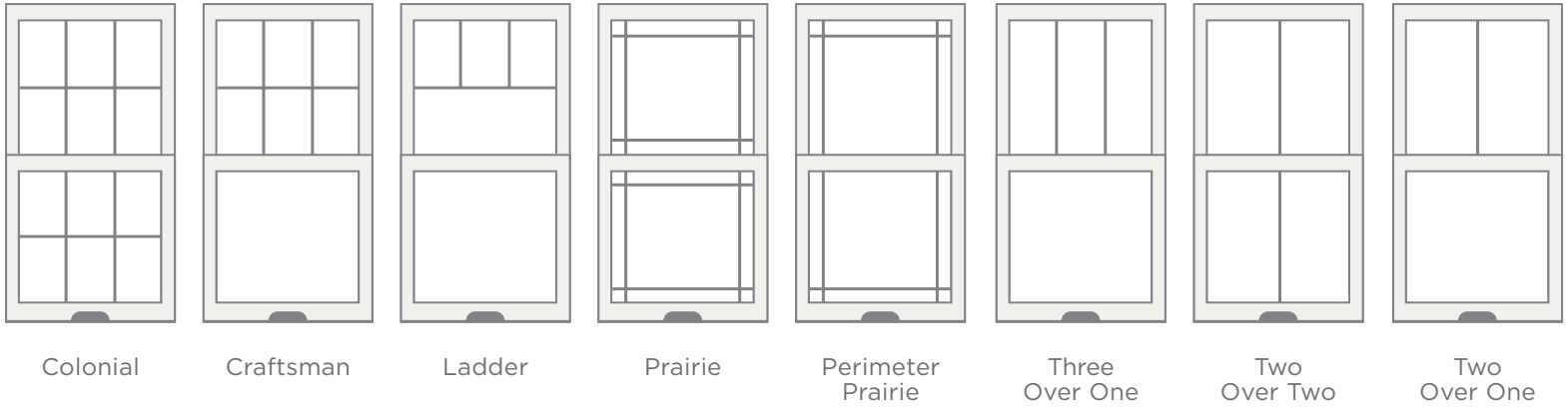

In-Glass Grilles

These are installed between the glass panes. You'll never have to clean them.



AVAILABLE SIZES	AVAILABLE COLOURS					
	WHITE	BEIGE	BLACK	BROWN	GREY	BLACK/WHITE
1" FLAT GRILLE	•	•	•			
5/8" FLAT GRILLE	•	•	•	•	•	•
5/16" FLAT GRILLE	•	•	•		•	

Simulated Divided Lites (SDL)

These are installed on the outer glass surfaces to simulate the look of divided panes.

1" SDL VINYL



1" SDL METAL CLAD VINYL

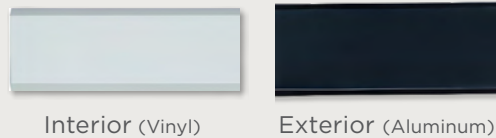

1" SDL METAL CLAD WOOD

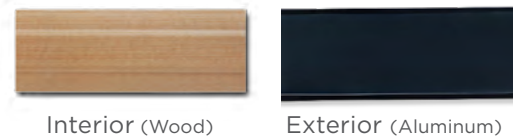

2" SML VINYL



2" SML METAL CLAD VINYL

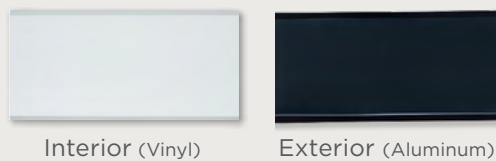

2" SML METAL CLAD WOOD



Exterior and interior materials and colours are matched to your windows.

Brickmould Options

Brickmould makes your windows appear more prominent and adds character to a home.

- ▶ Renovation brickmould has a removable cap and is available with a subsill or brickmould on all four sides.
- ▶ Rebate flush frame are ideal for replacing aluminum sliders.
- ▶ Brickmould and rebate flush frame available in all exterior frame colour options for that series.



Vinyl
Brickmould Corner



Clad
Brickmould Corner



Rebate Flush



	VINYL	CLAD VINYL	CLAD WOOD
2" 2-PART RENOVATION BRICKMOULD	•	•	•
REBATE FLUSH FRAME	•		

Colours are reproduced as accurately as printer technology allows.

Screens

SERIES	WHITE	BLACK	QUARTZ GREY	SLATE GREY	BROWN	PAINTABLE/ STAINABLE	CLEAR ANODIZED
VISTA WINDOWS	•						
COMFORT WINDOWS	•	•	•				
DESIGN WINDOWS	•	•	•				
DESIGN ARCHITECTURAL WINDOWS		•					
SIGNATURE WINDOWS	•	•				•	
COMFORT PATIO DOORS	•	•	•				
DESIGN PATIO DOORS		•		•	•		•
DESIGN ARCHITECTURAL PATIO DOORS		•		•	•		•
SIGNATURE 670 PATIO DOORS	•	•				•	

Jamb Liners

Jamb liners provide a clean transition between the window and interior trim. They cover the inside surface of the side jambs, the head jambs and sill. Available in vinyl, foam filled PVC, pine or pre-primed wood in sizes to fit all wall depths.

A drywall return channel, which connects to drywall or plywood used as interior jamb on the window frame, is available in 1/2" and 3/4" sizes.



Jamb Liners available in vinyl, foam filled PVC, pine or pre-primed wood



Drywall Returns

Hardware



Windows

Casement and Awning windows feature two different styles and colours of handle and lock hardware.

Classic Handle and Lock



Contemporary Handle and Lock*



*Black Contemporary handles and locks are the only options on Design Architectural series windows.

Sliding Patio Doors

Vinyl sliding patio doors come standard with stylish Sonoma hardware in two colours. Aluminum Clad Wood sliding patio doors come standard with Signature hardware for a choice of 2 designer colours which are available with a keylock. Design Series handles come standard with Aluminum Vinyl Clad sliding doors.

Sonoma Handle



Design Series Handle



Available on Design and Design Architectural Series Patio Doors

Signature Handle

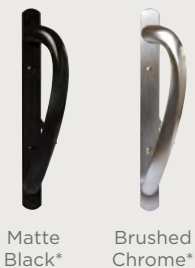

*Optional keylock available in all handle types

WINDOWS, SLIDING PATIO DOORS & HINGED PATIO DOORS



Hinged Patio Doors

Door handles add the finishing touch to our Signature Series hinged patio doors. We offer high quality Truth Sentry™ handles in a variety of attractive styles and finishes. Adjustable hinges in matching finishes are also available as an upgrade.



Transitional



Contemporary



Classic

Painted Finishes



Matte Black

Plated Finishes*

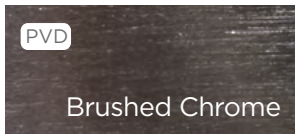

Brushed Chrome

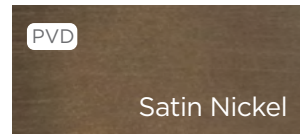

Satin Nickel

PVD Physical Vapor Deposition - PVD finish is extremely durable and environmentally-friendly.

Colours and finishes are reproduced as accurately as printer technology allows.

*Indicates additional cost.

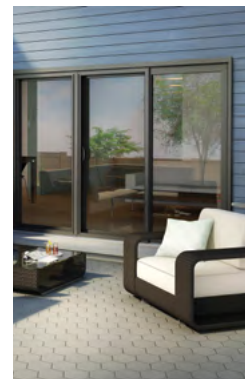
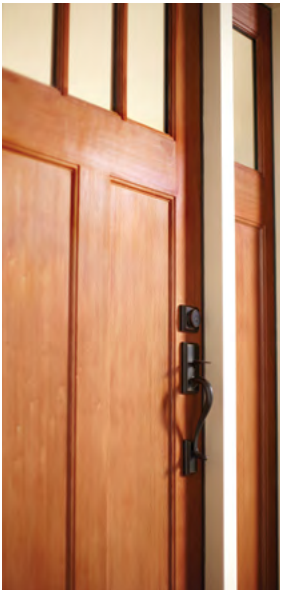

For more information
visit plygem.ca