

P/V

- Available Standard Size
- E Available Standard Size meets Canadian Egress Requirements (Egress based on equal Vent Height of 1/2 overall height)

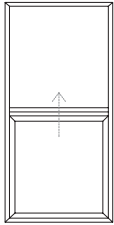

		Width									
		RO (Inches)	16 1/2	20 1/2	24 3/8	30 3/8	32 1/4	36 1/4	40 1/8	48	
Height	RO (mm)	420	520	620	770	820	920	1020	1220		
	OSM (Inches)	15 3/4	19 3/4	23 5/8	29 1/2	31 1/2	35 3/8	39 3/8	47 1/4		
	OSM (mm)	400	500	600	750	800	900	1000	1200		
	30 3/8	770	29 1/2	750	•	•	•	•	•	•	
	36 1/4	920	35 3/8	900	•	•	•	•	•	•	
	40 1/8	1020	39 3/8	1000	•	•	•	•	•	•	•
	48	1220	47 1/4	1200	•	•	•	•	•	•	E
	53 7/8	1370	53 1/8	1350	•	•	•	•	•	E	E
	59 7/8	1520	59	1500	•	•	•	E	E	E	E
	65 3/4	1670	65	1650	•	•	•	E	E	E	E
71 5/8	1820	70 7/8	1800	•	•	•	E	E	E	E	
83 1/2	2120	82 3/4	2100	•	•	E	E	E	E	E	

P/V|P/O

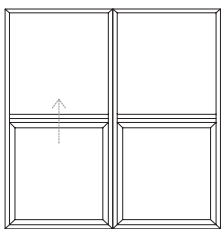

		Width									
		RO (Inches)	30 3/8	36 1/4	40 1/8	48	59 7/8	71 5/8	83 1/2	95 1/4	
Height	RO (mm)	770	920	1020	1220	1520	1820	2120	2420		
	OSM (Inches)	29 1/2	35 3/8	39 3/8	47 1/4	59	70 7/8	82 3/4	94 1/2		
	OSM (mm)	750	900	1000	1200	1500	1800	2100	2400		
	30 3/8	770	29 1/2	750	•	•	•	•	•	•	
	36 1/4	920	35 3/8	900	•	•	•	•	•	•	
	40 1/8	1020	39 3/8	1000	•	•	•	•	•	•	•
	48	1220	47 1/4	1200	•	•	•	•	•	•	E
	53 7/8	1370	53 1/8	1350	•	•	•	•	E	E	E
	59 7/8	1520	59	1500	•	•	•	•	E	E	E
	65 3/4	1670	65	1650	•	•	•	•	E	E	E
71 5/8	1820	70 7/8	1800	•	•	•	•	E	E	E	
83 1/2	2120	82 3/4	2100	•	•	•	E	E	E	E	

P/V|P|P/V

- Available Standard Size
- E Available Standard Size meets Canadian Egress Requirements
Egress based on vent width of 1/3 overall width

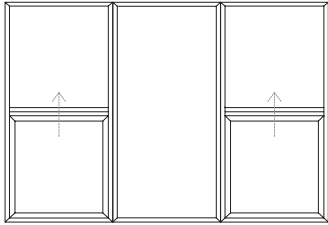

		Width							
Height	RO (Inches)		59 7/8	71 5/8	83 1/2	95 1/4	107 1/8	118 7/8	
	RO (mm)	OSM (Inches)		1520	1820	2120	2420	2720	3020
		OSM (mm)		59	70 7/8	82 3/4	94 1/2	106 1/4	118 1/8
				OSM (mm)	1500	1800	2100	2400	2700
30 3/8	770	29 1/2	750	•	•	•	•		
40 1/8	1020	39 3/8	1000	•	•	•	•	•	•
48	1220	47 1/4	1200	•	•	•	•	•	E
53 7/8	1370	53 1/8	1350	•	•	•	•	E	E
59 7/8	1520	59	1500	•	•	•	E	E	E
65 3/4	1670	65	1650	•	•	E	E	E	E
71 5/8	1820	70 7/8	1800	•	•	E	E	E	E
83 1/2	2120	82 3/4	2100	•	•	E	E	E	E

P|P/V|P

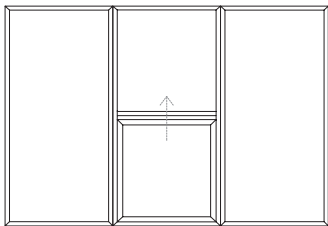

		Width								
Height	RO (Inches)		48	59 7/8	71 5/8	83 1/2	95 1/4	107 1/8	118 7/8	
	RO (mm)	OSM (Inches)		1220	1520	1820	2120	2420	2720	3020
		OSM (mm)		47 1/4	59	70 7/8	82 3/4	94 1/2	106 1/4	118 1/8
				OSM (mm)	1200	1500	1800	2100	2400	2700
30 3/8	770	29 1/2	750	•	•	•	•	•		
40 1/8	1020	39 3/8	1000	•	•	•	•	•	•	
48	1220	47 1/4	1200	•	•	•	•	•	E	
53 7/8	1370	53 1/8	1350	•	•	•	•	E	E	
59 7/8	1520	59	1500	•	•	•	•	E	E	
65 3/4	1670	65	1650	•	•	•	E	E	E	
71 5/8	1820	70 7/8	1800	•	•	E	E	E	E	
83 1/2	2120	82 3/4	2100	•	•	E	E	E	E	

XO

- Available Standard Size
- E Available Standard Size meets Canadian Egress Requirements
Egress based on vent width of 600

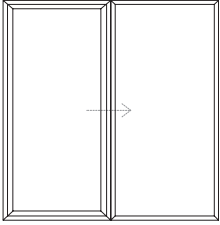

		Width								
Height	RO (Inches)		30 3/8	36 1/4	40 1/8	48	59 7/8	71 5/8	83 1/2	
	RO (mm)		770	920	1020	1220	1520	1820	2120	
	OSM (Inches)		29 1/2	35 3/8	39 3/8	47 1/4	59	70 7/8	82 3/4	
	OSM (mm)		750	900	1000	1200	1500	1800	2100	
20 1/2	520	19 3/4	500	•	•	•	•	•	•	
24 3/8	620	23 3/4	600	•	•	•	•	•	E	E
30 3/8	770	29 1/2	750	•	•	•	•	E	E	E
32 1/4	820	31 1/2	800		•	•	•	E	E	E
36 1/4	920	35 3/8	900		•	•	E	E	E	E
40 1/8	1020	39 3/8	1000		•	•	E	E	E	E
48	1220	47 1/4	1200		•	E	E	E	E	E
53 7/8	1370	53 1/8	1350			E	E	E	E	E
59 7/8	1520	59	1500			E	E	E	E	E

XP

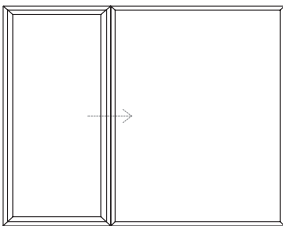

		Width									
Height	RO (Inches)		48	59 7/8	71 5/8	83 1/2	95 1/4	107 1/8	118 7/8		
	RO (mm)		1220	1520	1820	2120	2420	2720	3020		
	OSM (Inches)		47 1/4	59	70 7/8	82 3/4	94 1/2	106 1/4	118 1/8		
	OSM (mm)		1200	1500	1800	2100	2400	2700	3000		
20 1/2	520	19 3/4	500	•	•	•	•	•	•	•	
24 3/8	620	23 5/8	600	•	•	•	•	•	•	•	
30 3/8	770	29 1/2	750	•	•	•	•	•	•	•	
32 1/4	820	31 1/2	800	•	•	•	•	•	•	•	
36 1/4	920	35 3/8	900	E	E	E	E	E	E	E	
40 1/8	1020	39 3/8	1000	E	E	E	E	E	E	E	
48	1220	47 1/4	1200	E	E	E	E	E	E	E	
53 7/8	1370	53 1/8	1350	E	E	E	E	E	E	E	
59 7/8	1520	59	1500	E	E	E	E	E	E	E	

XPX

- Available Standard Size
- E Available Standard Size meets Canadian Egress Requirements
- Egress based on vent width of 600
- Egress based on vent height of 600 and equal Vent width of 1/2 overall width for P/XO

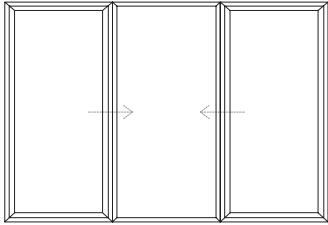

		Width								
Height	RO (Inches)			48	59 7/8	71 5/8	83 1/2	95 1/4	107 1/8	118 7/8
		RO (mm)		1220	1520	1820	2120	2420	2720	3020
			OSM (Inches)	47 1/4	59	70 7/8	82 3/4	94 1/2	106 1/4	118 1/8
			OSM (mm)	1200	1500	1800	2100	2400	2700	3000
	20 1/2	520	19 3/4	500	•	•	•	•	•	•
	24 3/8	620	23 5/8	600	•	•	•	•	•	•
	30 3/8	770	29 1/2	750	•	•	•	•	•	•
	32 1/4	820	31 1/2	800	•	•	•	•	•	•
	36 1/4	920	35 3/8	900	•	•	E	E	E	E
	40 1/8	1020	39 3/8	1000	•	•	E	E	E	E
48	1220	47 1/4	1200	•	•	E	E	E	E	
53 7/8	1370	53 1/8	1350		•	E	E	E	E	
59 7/8	1520	59	1500		•	E	E	E	E	

P/XO

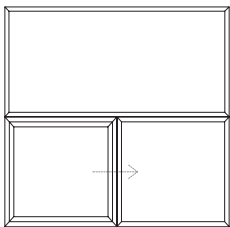

		Width						
Height	RO (Inches)			40 1/8	48	59 7/8	71 5/8	83 1/2
		RO (mm)		1020	1220	1520	1820	2120
			OSM (Inches)	39 3/8	47 1/4	59	70 7/8	82 3/4
			OSM (mm)	1000	1200	1500	1800	2100
	36 1/4	920	35 3/8	900	•	•	•	•
	40 1/8	1020	39 3/8	1000	•	•	•	•
	48	1220	47 1/4	1200	•	•	•	E
	53 7/8	1370	53 1/8	1350	•	•	•	E
	59 7/8	1520	59	1500	•	•	•	E
	65 3/4	1670	65	1650	•	•	•	E
71 5/8	1820	70 7/8	1800	•	•	•	E	
83 1/2	2120	82 3/4	2100	•	•	•	E	
95 1/4	2420	94 1/2	2400	•	•	•	E	

A

- Available Standard Size
Awnings do not meet Egress
Maximum sash weight is 60 lbs

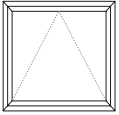

		Width									
		RO (Inches)		20 1/2	24 3/8	30 3/8	36 1/4	40 1/8	48	59 7/8	
		RO (mm)		520	620	770	920	1020	1220	1520	
		OSM (Inches)		19 3/4	23 5/8	29 1/2	35 3/8	39 3/8	47 1/4	59	
		OSM (mm)		500	600	750	900	1000	1200	1500	
Height	20 1/2	520	19 3/4	500	•	•	•	•	•	•	•
	24 3/8	620	23 5/8	600	•	•	•	•	•	•	•
	32 1/4	820	31 1/2	800	•	•	•	•	•	•	•
	36 1/4	920	35 3/8	900	•	•	•	•	•	•	•
	40 1/8	1020	39 3/8	1000	•	•	•	•	•	•	•
	48	1220	47 1/4	1200	•	•	•	•	•	•	•

AO or AF



		Width										
		RO (Inches)		40 1/8	48	59 7/8	71 5/8	79 1/2	83 1/2	95 1/4	107 1/8	118 7/8
		RO (mm)		1020	1220	1520	1820	2020	2120	2420	2720	3020
		OSM (Inches)		39 3/8	47 1/4	59	70 7/8	78 3/4	82 3/4	94 1/2	106 1/4	118 1/8
		OSM (mm)		1000	1200	1500	1800	2000	2100	2400	2700	3000
Height	20 1/2	520	19 3/4	500	•	•	•	•	•	•	•	•
	24 3/8	620	23 5/8	600	•	•	•	•	•	•	•	•
	32 1/4	820	31 1/2	800	•	•	•	•	•	•	•	•
	36 1/4	920	35 3/8	900	•	•	•	•	•	•	•	•
	40 1/8	1020	39 3/8	1000	•	•	•	•	•	•	•	•
	48	1220	47 1/4	1200	•	•	•	•	•	•	•	•

P/A or F/A

- Available Standard Size
Awnings do not meet Egress
Maximum sash weight is 60 lbs

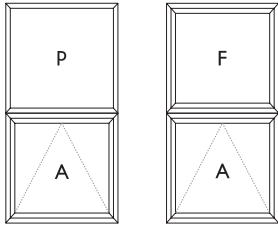

		Width									
Height	RO (Inches)		24 3/8	30 3/8	32 1/4	36 1/4	40 1/8	48	59 7/8		
	RO (mm)		620	770	820	920	1020	1220	1520		
	OSM (Inches)		23 5/8	29 1/2	31 1/2	35 3/8	39 3/8	47 1/4	59		
	OSM (mm)		600	750	800	900	1000	1200	1500		
32 1/4	820	31 1/2	800	•	•	•	•	•	•	•	•
36 1/4	920	35 3/8	900	•	•	•	•	•	•	•	•
40 1/8	1020	39 3/8	1000	•	•	•	•	•	•	•	•
48	1220	47 1/4	1200	•	•	•	•	•	•	•	•
53 7/8	1370	53 1/8	1350	•	•	•	•	•	•	•	•
59 7/8	1520	59	1500	•	•	•	•	•	•	•	•
65 3/4	1670	65	1650	•	•	•	•	•	•	•	•
71 5/8	1820	70 7/8	1800	•	•	•	•	•	•	•	•
83 1/2	2120	82 3/4	2100	•	•	•	•	•	•	•	•
95 1/4	2420	94 1/2	2400	•	•	•	•	•	•	•	•
107 1/8	2720	106 1/4	2700	•	•	•	•	•	•	•	•

P/A|P/A or F/A|F/A

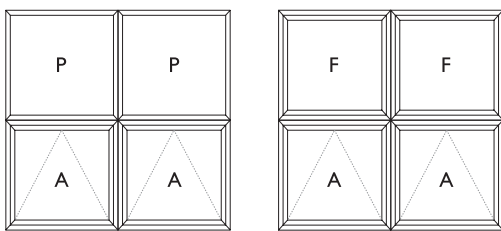

		Width										
Height	RO (Inches)		40 1/8	48	59 7/8	71 5/8	83 1/2	95 1/4	107 1/8	118 7/8		
	RO (mm)		1020	1220	1520	1820	2120	2420	2720	3020		
	OSM (Inches)		39 3/8	47 1/4	59	70 7/8	82 3/4	94 1/2	106 1/4	118 1/8		
	OSM (mm)		1000	1200	1500	1800	2100	2400	2700	3000		
32 1/4	820	31 1/2	800	•	•	•	•	•	•	•	•	
36 1/4	920	35 3/8	900	•	•	•	•	•	•	•	•	
40 1/8	1020	39 3/8	1000	•	•	•	•	•	•	•	•	
48	1220	47 1/4	1200	•	•	•	•	•	•	•	•	
53 7/8	1370	53 1/8	1350	•	•	•	•	•	•	•	•	
59 7/8	1520	59	1500	•	•	•	•	•	•	•	•	
65 3/4	1670	65	1650	•	•	•	•	•	•	•	•	
71 5/8	1820	70 7/8	1800	•	•	•	•	•	•	•	•	
83 1/2	2120	82 3/4	2100	•	•	•	•	•	•	•	•	
95 1/4	2420	94 1/2	2400	•	•	•	•	•	•	•	•	
107 1/8	2720	106 1/4	2700	•	•	•	•	•	•	•	•	

P/AO or F/AF

- Available Standard Size
Awnings do not meet Egress
Maximum sash weight is 60 lbs

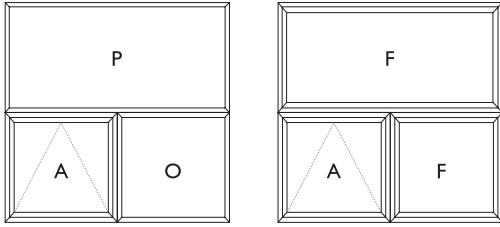

		Width										
		RO (Inches)	RO (mm)		OSM (Inches)	OSM (mm)		40 1/8	48	59 7/8	71 5/8	83 1/2
Height	32 1/4	820	31 1/2	800	•	•	•	•	•	•	•	•
	36 1/4	920	35 3/8	900	•	•	•	•	•	•	•	•
	40 1/8	1020	39 3/8	1000	•	•	•	•	•	•	•	•
	48	1220	47 1/4	1200	•	•	•	•	•	•	•	•
	53 7/8	1370	53 1/8	1350	•	•	•	•	•	•	•	•
	59 7/8	1520	59	1500	•	•	•	•	•	•	•	•
	65 3/4	1670	65	1650	•	•	•	•	•	•	•	•
	71 5/8	1820	70 7/8	1800	•	•	•	•	•	•	•	•
	83 1/2	2120	82 3/4	2100	•	•	•	•	•	•	•	•
	95 1/4	2420	94 1/2	2400	•	•	•	•	•	•	•	•
	107 1/8	2720	106 1/4	2700	•	•	•	•	•	•	•	•

L

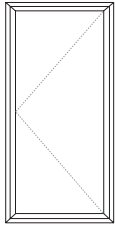

- Available Standard Size
 - E Available Standard Size meets Canadian Egress Requirements
 - E* Available Standard Size meets Canadian Egress Requirements with Egress Hinge
- Maximum sash weight is 64 lbs

		Width									
		RO (Inches)	14 5/8	16 1/2	20 1/2	24 3/8	30 3/8	32 1/4	36 1/4		
Height	RO (Inches)	RO (mm)	370	420	520	620	770	820	920		
		OSM (Inches)	OSM (mm)	13 3/4	15 3/4	19 3/4	23 5/8	29 1/2	35 3/8	35 3/8	
	20 1/2		520	19 3/4	500	•	•	•	•	•	•
	32 1/4	820	31 1/2	800	•	•	•	•	•	E	E
	36 1/4	920	35 3/8	900	•	•	•	•	E	E	E
	40 1/8	1020	39 3/8	1000	•	•	•	E*	E	E	E
	48	1220	47 1/4	1200	•	•	•	E*	E	E	E
	53 7/8	1370	53 1/8	1350	•	•	•	E*	E	E	E
	59 7/8	1520	59	1500	•	•	•	E*	E	E	E
	65 3/4	1670	65	1650	•	•	•	E*	E	E	E
	71 5/8	1820	70 7/8	1800	•	•	•	E*	E	E	E
83 1/2	2120	82 3/4	2100	•	•	•	E*	E			

LR

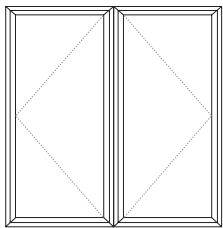

		Width								
		RO (Inches)	36 1/4	40 1/8	48	59 7/8	63 3/4	71 5/8		
Height	RO (Inches)	RO (mm)	920	1020	1220	1520	1620	1820		
		OSM (Inches)	OSM (mm)	35 3/8	39 3/8	47 1/4	59	63	70 7/8	
	20 1/2		520	19 3/4	500	•	•	•	•	•
	32 1/4	820	31 1/2	800	•	•	•	•	E	E
	36 1/4	920	35 3/8	900	•	•	•	•	E	E
	40 1/8	1020	39 3/8	1000	•	•	E*	E	E	E
	48	1220	47 1/4	1200	•	•	E*	E	E	E
	53 7/8	1370	53 1/8	1350	•	•	E*	E	E	E
	59 7/8	1520	59	1500	•	•	E*	E	E	E
	65 3/4	1670	65	1650	•	•	E*	E	E	E
	71 5/8	1820	70 7/8	1800	•	•	E*	E	E	E
83 1/2	2120	82 3/4	2100	•	•	E*	E			

LO or LF

- Available Standard Size
 - E Available Standard Size meets Canadian Egress Requirements
 - E* Available Standard Size meets Canadian Egress Requirements with Egress Hinge
- Egress based on vent width of 600 for LP and LF
Maximum sash weight is 64 lbs

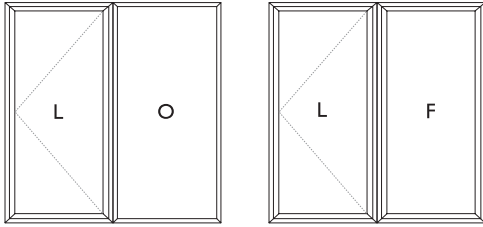

		Width							
		RO (Inches)	36 1/4	40 1/8	48	59 7/8	63 3/4	71 5/8	
Height	RO (mm)	920	1020	1220	1520	1620	1820		
		OSM (Inches)		35 3/8	39 3/8	47 1/4	59	63	70 7/8
		OSM (mm)	900	1000	1200	1500	1600	1800	
	20 1/2	520	19 3/4	500	•	•	•	•	•
	32 1/4	820	31 1/2	800	•	•	•	•	E
	36 1/4	920	35 3/8	900	•	•	•	E	E
	40 1/8	1020	39 3/8	1000	•	•	E*	E	E
	48	1220	47 1/4	1200	•	•	E*	E	E
	53 7/8	1370	53 1/8	1350	•	•	E*	E	E
	59 7/8	1520	59	1500	•	•	E*	E	E
65 3/4	1670	65	1650	•	•	E*	E	E	
71 5/8	1820	70 7/8	1800	•	•	E*	E	E	
83 1/2	2120	82 3/4	2100	•	•	E*	E		

LP or LF

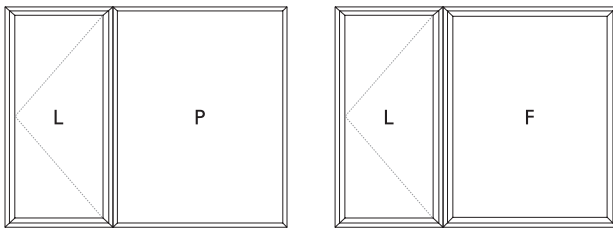

		Width											
		RO (Inches)	36 1/4	40 1/8	48	59 7/8	63 3/4	71 5/8	83 1/2	95 1/4	107 1/8	118 7/8	
Height	RO (mm)	920	1020	1220	1520	1620	1820	2120	2420	2720	3020		
		OSM (Inches)		35 3/8	39 3/8	47 1/4	59	63	70 7/8	82 3/4	94 1/2	106 1/4	118 1/8
		OSM (mm)	900	1000	1200	1500	1600	1800	2100	2400	2700	3000	
	20 1/2	520	19 3/4	500	•	•	•	•	•	•	•	•	
	32 1/4	820	31 1/2	800	•	•	•	•	•	•	•	•	
	36 1/4	920	35 3/8	900	•	•	•	•	•	•	•	•	
	40 1/8	1020	39 3/8	1000	•	•	E*	E*	E*	E*	E*	E*	
	48	1220	47 1/4	1200	•	•	E*	E*	E*	E*	E*	E*	
	53 7/8	1370	53 1/8	1350	•	•	E*	E*	E*	E*	E*	E*	
	59 7/8	1520	59	1500	•	•	E*	E*	E*	E*	E*	E*	
65 3/4	1670	65	1650	•	•	E*	E*	E*	E*	E*	E*		
71 5/8	1820	70 7/8	1800	•	•	E*	E*	E*	E*	E*	E*		
83 1/2	2120	82 3/4	2100	•	•	E*	E*	E*	E*	E*	E*		

LPO or LFF

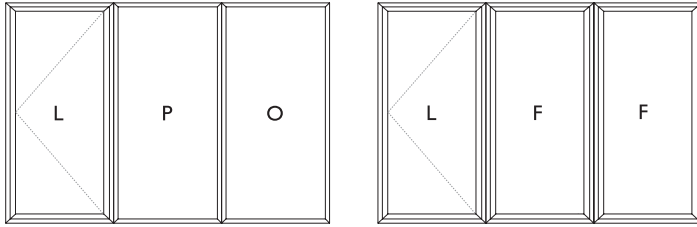

- Available Standard Size
 - E Available Standard Size meets Canadian Egress Requirements
 - E* Available Standard Size meets Canadian Egress Requirements with Egress Hinge
- Egress calculations assume equal splits up to 1800 mm wide, then 600 mm sash widths for sized beyond 1800 mm LPO or LFF
Acoustical glazing not available in all sizes for LPR or LFR
Maximum sash weight is 64 lbs

		Width								
		RO (Inches)	59 7/8	63 3/4	71 5/8	83 1/2	95 1/4	107 1/8	118 7/8	
Height	RO (mm)	1520	1620	1820	2120	2420	2720	3020		
	OSM (Inches)	59	63	70 7/8	82 3/4	94 1/2	106 1/4	118 1/8		
		OSM (mm)	1500	1600	1800	2100	2400	2700	3000	
	20 1/2	520	19 3/4	500	•	•	•	•	•	•
	32 1/4	820	31 1/2	800	•	•	•	•	•	•
	36 1/4	920	35 3/8	900	•	•	•	•	•	•
	40 1/8	1020	39 3/8	1000	•	•	E*	E*	E*	E*
	48	1220	47 1/4	1200	•	•	E*	E*	E*	E*
	53 7/8	1370	53 1/8	1350	•	•	E*	E*	E*	E*
	59 7/8	1520	59	1500	•	•	E*	E*	E*	E*
	65 3/4	1670	65	1650	•	•	E*	E*	E*	E*
	71 5/8	1820	70 7/8	1800	•	•	E*	E*	E*	E*
83 1/2	2120	82 3/4	2100	•	•	E*	E*	E*	E*	

LPR or LFR

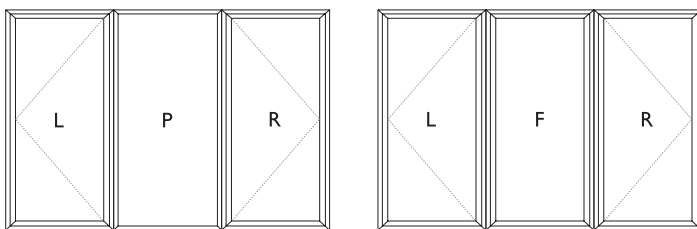

		Width								
		RO (Inches)	59 7/8	63 3/4	71 5/8	83 1/2	95 1/4	107 1/8	118 7/8	
Height	RO (mm)	1520	1620	1820	2120	2420	2720	3020		
	OSM (Inches)	59	63	70 7/8	82 3/4	94 1/2	106 1/4	118 1/8		
		OSM (mm)	1500	1600	1800	2100	2400	2700	3000	
	20 1/2	520	19 3/4	500	•	•	•	•	•	•
	32 1/4	820	31 1/2	800	•	•	•	•	•	•
	36 1/4	920	35 3/8	900	•	•	E*	E*	E*	E*
	40 1/8	1020	39 3/8	1000	•	•	E*	E*	E*	E*
	48	1220	47 1/4	1200	•	•	E*	E*	E*	E*
	53 7/8	1370	53 1/8	1350	•	•	E*	E*	E*	E*
	59 7/8	1520	59	1500	•	•	E*	E*	E*	E*
	65 3/4	1670	65	1650	•	•	E*	E*	E*	E*
	71 5/8	1820	70 7/8	1800	•	•	E*	E*	E*	E*
83 1/2	2120	82 3/4	2100	•	•	E*	E*	E*	E*	

O

• Available Standard Size

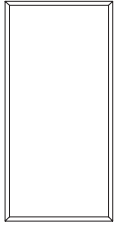

		Width															
Height	RO (Inches)	12 5/8	16 1/2	20 1/2	24 3/8	30 3/8	32 1/4	36 1/4	40 1/8	48	59 7/8	71 5/8	83 1/2	95 1/4	107 1/8	118 7/8	
	RO (mm)	320	420	520	620	770	820	920	1020	1220	1520	1820	2120	2420	2720	3020	
	OSM (Inches)	11 3/4	15 3/4	19 3/4	23 5/8	29 1/2	35 3/8	35 3/8	39 3/8	47 1/4	59	70 7/8	82 3/4	94 1/2	106 1/4	118 1/8	
	OSM (mm)	300	400	500	600	750	800	900	1000	1200	1500	1800	2100	2400	2700	3000	
12 5/8	320	11 3/4	300		•	•	•	•	•	•	•	•	•	•	•	•	
24 3/8	620	23 5/8	600		•	•	•	•	•	•	•	•	•	•	•	•	
30 3/8	770	29 1/2	750		•	•	•	•	•	•	•	•	•	•	•	•	
32 1/4	820	31 1/2	800		•	•	•	•	•	•	•	•	•	•	•	•	
36 1/4	920	35 3/8	900		•	•	•	•	•	•	•	•	•	•	•	•	
40 1/8	1020	39 3/8	1000		•	•	•	•	•	•	•	•	•	•	•	•	
48	1220	47 1/4	1200		•	•	•	•	•	•	•	•	•	•	•	•	
53 7/8	1370	53 1/8	1350		•	•	•	•	•	•	•	•	•	•	•	•	
59 7/8	1520	59	1500		•	•	•	•	•	•	•	•	•	•	•	•	
65 3/4	1670	65	1650		•	•	•	•	•	•	•	•	•	•	•	•	
71 5/8	1820	70 7/8	1800		•	•	•	•	•	•	•	•	•	•	•	•	
83 1/2	2120	82 3/4	2100		•	•	•	•	•	•	•	•	•	•	•	•	

OO

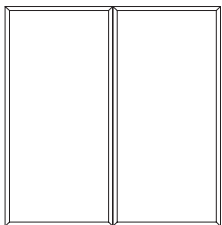

		Width										
Height	RO (Inches)	24 3/8	30 3/8	36 1/4	40 1/8	48	59 7/8	71 5/8	83 1/2	95 1/4	107 1/8	118 7/8
	RO (mm)	620	770	920	1020	1220	1520	1820	2120	2420	2720	3020
	OSM (Inches)	23 5/8	29 1/2	35 3/8	39 3/8	47 1/4	59	70 7/8	82 3/4	94 1/2	106 1/4	118 1/8
	OSM (mm)	600	750	900	1000	1200	1500	1800	2100	2400	2700	3000
12 5/8	320	11 3/4	300		•	•	•	•	•	•	•	•
24 3/8	620	23 5/8	600		•	•	•	•	•	•	•	•
30 3/8	770	29 1/2	750		•	•	•	•	•	•	•	•
32 1/4	820	31 1/2	800		•	•	•	•	•	•	•	•
36 1/4	920	35 3/8	900		•	•	•	•	•	•	•	•
40 1/8	1020	39 3/8	1000		•	•	•	•	•	•	•	•
48	1220	47 1/4	1200		•	•	•	•	•	•	•	•
53 7/8	1370	53 1/8	1350		•	•	•	•	•	•	•	•
59 7/8	1520	59	1500		•	•	•	•	•	•	•	•
65 3/4	1670	65	1650		•	•	•	•	•	•	•	•
71 5/8	1820	70 7/8	1800		•	•	•	•	•	•	•	•
83 1/2	2120	82 3/4	2100		•	•	•	•	•	•	•	•



P/O

- Available Standard Size

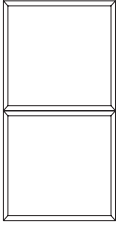

		Width													
Height	RO (Inches)			16 1/2	20 1/2	24 3/8	30 3/8	36 1/4	40 1/8	48	59 7/8	71 5/8	83 1/2		
		RO (mm)			420	520	620	770	920	1020	1220	1520	1820	2120	
			OSM (Inches)			15 3/4	19 3/4	23 5/8	29 1/2	35 3/8	39 3/8	47 1/4	59	70 7/8	82 3/4
				OSM (mm)			400	500	600	750	900	1000	1200	1500	1800
48	1220	47 1/4	1200	•	•	•	•	•	•	•	•	•	•	•	•
53 7/8	1370	53 1/8	1350	•	•	•	•	•	•	•	•	•	•	•	•
59 7/8	1520	59	1500	•	•	•	•	•	•	•	•	•	•	•	•
65 3/4	1670	65	1650	•	•	•	•	•	•	•	•	•	•	•	•
71 5/8	1820	70 7/8	1800	•	•	•	•	•	•	•	•	•	•	•	•
83 1/2	2120	82 3/4	2100	•	•	•	•	•	•	•	•	•	•	•	•
95 1/4	2420	94 1/2	2400	•	•	•	•	•	•	•	•	•	•	•	•
107 1/8	2720	106 1/4	2700	•	•	•	•	•	•	•	•	•	•	•	•

F

- Available Standard Size
- E Available Standard Size meets Canadian Egress Requirements

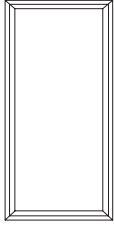

		Width											
Height	RO (Inches)		20 1/2	24 3/8	30 3/8	32 1/4	36 1/4	40 1/8	48	59 7/8	71 5/8	83 1/2	
	RO (mm)	OSM (Inches)		520	620	770	820	920	1020	1220	1520	1820	2120
		OSM (mm)		19 3/4	23 5/8	29 1/2	35 3/8	35 3/8	39 3/8	47 1/4	59	70 7/8	82 3/4
				500	600	750	800	900	1000	1200	1500	1800	2100
24 3/8	620	23 5/8	600	•	•	•	•	•	•	•	•	•	
30 3/8	770	29 1/2	750	•	•	•	•	•	•	•	•	•	
32 1/4	820	31 1/2	800	•	•	•	•	•	•	•	•	•	
36 1/4	920	35 3/8	900	•	•	•	•	•	•	•	•	•	
40 1/8	1020	39 3/8	1000	•	•	•	•	•	•	•	•	•	
48	1220	47 1/4	1200	•	•	•	•	•	•	•	•	•	
53 7/8	1370	53 1/8	1350	•	•	•	•	•	•	•	•	•	
59 7/8	1520	59	1500	•	•	•	•	•	•	•	•	•	
65 3/4	1670	65	1650	•	•	•	•	•	•	•	•	•	
71 5/8	1820	70 7/8	1800	•	•	•	•	•	•	•	•	•	
83 1/2	2120	82 3/4	2100	•	•	•	•	•	•	•	•	•	

FF

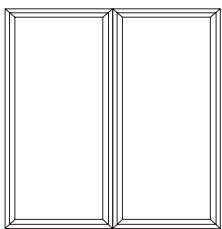

		Width											
Height	RO (Inches)		30 3/8	36 1/4	40 1/8	48	59 7/8	71 5/8	83 1/2	95 1/4	107 1/8	118 7/8	
	RO (mm)	OSM (Inches)		770	920	1020	1220	1520	1820	2120	2420	3020	
		OSM (mm)		29 1/2	35 3/8	39 3/8	47 1/4	59	70 7/8	82 3/4	94 1/2	106 1/4	118 1/8
				750	900	1000	1200	1500	1800	2100	2400	2700	3000
24 3/8	620	23 5/8	600	•	•	•	•	•	•	•	•	•	
30 3/8	770	29 1/2	750	•	•	•	•	•	•	•	•	•	
32 1/4	820	31 1/2	800	•	•	•	•	•	•	•	•	•	
36 1/4	920	35 3/8	900	•	•	•	•	•	•	•	•	•	
40 1/8	1020	39 3/8	1000	•	•	•	•	•	•	•	•	•	
48	1220	47 1/4	1200	•	•	•	•	•	•	•	•	•	
53 7/8	1370	53 1/8	1350	•	•	•	•	•	•	•	•	•	
59 7/8	1520	59	1500	•	•	•	•	•	•	•	•	•	
65 3/4	1670	65	1650	•	•	•	•	•	•	•	•	•	
71 5/8	1820	70 7/8	1800	•	•	•	•	•	•	•	•	•	
83 1/2	2120	82 3/4	2100	•	•	•	•	•	•	•	•	•	

FFF

- Available Standard Size
- E Available Standard Size meets Canadian Egress Requirements

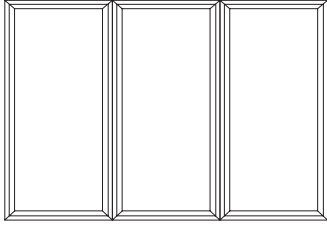

		Width											
Height	RO (Inches)			40 1/8	48	59 7/8	71 5/8	83 1/2	95 1/4	107 1/8	118 7/8		
		RO (mm)			1020	1220	1520	1820	2120	2420	2720	3020	
			OSM (Inches)			39 3/8	47 1/4	59	70 7/8	82 3/4	94 1/2	106 1/4	118 1/8
				OSM (mm)			1000	1200	1500	1800	2100	2400	2700
	24 3/8	620	23 5/8	600	•	•	•	•	•	•	•	•	•
	30 3/8	770	29 1/2	750	•	•	•	•	•	•	•	•	•
	32 1/4	820	31 1/2	800	•	•	•	•	•	•	•	•	•
	36 1/4	920	35 3/8	900	•	•	•	•	•	•	•	•	•
	40 1/8	1020	39 3/8	1000	•	•	•	•	•	•	•	•	•
	48	1220	47 1/4	1200	•	•	•	•	•	•	•	•	•
	53 7/8	1370	53 1/8	1350	•	•	•	•	•	•	•	•	•
	59 7/8	1520	59	1500	•	•	•	•	•	•	•	•	•
	65 3/4	1670	65	1650	•	•	•	•	•	•	•	•	•
	71 5/8	1820	70 7/8	1800	•	•	•	•	•	•	•	•	•
	83 1/2	2120	82 3/4	2100	•	•	•	•	•	•	•	•	•

Half Round

• Available Standard Size



		Width												
Height	RO (Inches)	24 3/8	30 3/8	36 1/4	40 1/8	48	59 7/8	71 5/8	79 1/2	83 1/2	87 3/8	95 1/4		
	RO (mm)	620	770	920	1020	1220	1520	1820	2020	2120	2220	2420		
	OSM (Inches)	23 5/8	29 1/2	35 3/8	39 3/8	47 1/4	59	70 7/8	78 3/4	82 3/4	86 5/8	94 1/2		
	OSM (mm)	600	750	900	1000	1200	1500	1800	2000	2100	2200	2400		
13 5/8	346	12 7/8	326	•										
16 5/8	422	15 7/8	402		•									
19 1/2	495	18 3/4	475			•								
21 1/2	546	20 3/4	526				•							
25 3/8	645	24 5/8	625					•						
31 3/8	797	30 5/8	777						•					
37 1/4	946	36 1/2	926							•				
41 1/8	1045	40 3/8	1025								•			
43 1/8	1095	42 3/8	1075									•		
45 1/8	1146	44 3/8	1126										•	
49	1245	48 1/4	1225											•

Arch (Extended Half Round)

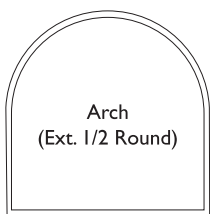

		Width										
Height	RO (Inches)	24 3/8	30 3/8	32 1/4	36 1/4	40 1/8	48	59 7/8	71 5/8	83 1/2		
	RO (mm)	620	770	820	920	1020	1220	1520	1820	2120		
	OSM (Inches)	23 5/8	29 1/2	35 3/8		39 3/8	47 1/4	59	70 7/8	82 3/4		
	OSM (mm)	600	750	800	900	1000	1200	1500	1800	2100		
20 1/2	520	19 3/4	500	•								
24 3/8	620	23 5/8	600	•								
32 1/4	820	31 1/2	800	•	•	•	•	•				
36 1/4	920	35 3/8	900	•	•	•	•	•	•			
40 1/8	1020	39 3/8	1000	•	•	•	•	•	•			
48	1220	47 1/4	1200	•	•	•	•	•	•	•		
59 7/8	1520	59	1500	•	•	•	•	•	•	•		
71 5/8	1820	70 7/8	1800	•	•	•	•	•	•	•		
83 1/2	2120	82 3/4	2100	•	•	•	•	•	•	•		
95 1/4	2420	94 1/2	2400		•		•	•	•			
107 1/8	2720	106 1/4	2700				•	•				
118 7/8	3020	118 1/8	3000				•	•				

Quarter Round and Extended Quarter Round

- Available Standard Size for Quarter Round
- Available Standard Size for Extended Quarter Round
- Available Standard Size for both

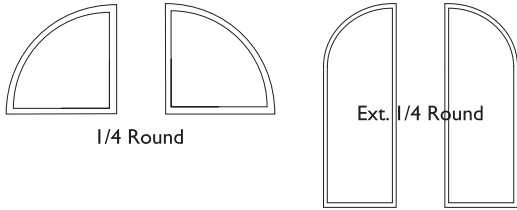

		Width										
RO (Inches)		12 5/8	16 1/2	20 1/2	24 3/8	30 3/8	36 1/4	40 1/8	44 1/8	48	59 7/8	71 5/8
RO (mm)		320	420	520	620	770	920	1020	1120	1220	1520	1820
OSM (Inches)		11 3/4	15 3/4	19 3/4	23 5/8	35 3/8	35 3/8	39 3/8	43 3/8	47 1/4	59	70 7/8
OSM (mm)		300	400	500	600	750	900	1000	1100	1200	1500	1800
Height	12 5/8	320	11 3/4	300	•							
	16 1/2	420	15 3/4	400		•						
	18 1/2	470	17 3/4	450	•							
	20 1/2	520	19 3/4	500			•					
	24 3/8	620	23 5/8	600	•			•				
	30 3/8	770	35 3/8	750				•				
	36 1/4	920	35 3/8	900	•		•	•	•			
	40 1/8	1020	1 6/7	1000						•		
	44 1/8	1120	43 3/8	1100							•	
	48	1220	47 1/4	1200	•		•	•	•	•	•	
	53 7/8	1370	53 1/8	1350	•		•	•	•	•	•	•
	59 7/8	1520	59	1500	•		•	•	•	•	•	•
	65 3/4	1670	65	1650	•		•	•	•	•	•	•
	71 5/8	1820	70 7/8	1800	•		•	•	•	•	•	•
	83 1/2	2120	82 3/4	2100	•		•	•	•	•	•	•
	95 1/4	2420	94 1/2	2400	•		•	•	•	•	•	•
107 1/8	2720	106 1/4	2700	•		•	•	•	•	•	•	

Segmental and Extended Segmental

- Available Standard Size for Segmental/Partial Segmental
- Available Standard Size for Extended Segmental/Partial Segmental
- Available Standard Size for both

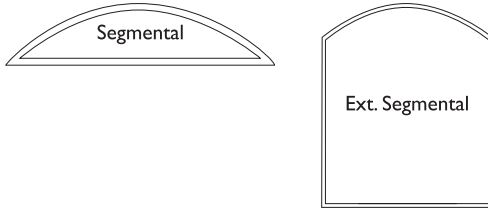

		Width												
		RO (Inches)	24 3/8	30 3/8	36 1/4	40 1/8	48	59 7/8	71 5/8	83 1/2	87 3/8	95 1/4		
		RO (mm)	620	770	920	1020	1220	1520	1820	2120	2220	2420		
		OSM (Inches)	23 5/8	35 3/8	35 3/8	39 3/8	47 1/4	59	70 7/8	82 3/4	86 5/8	94 1/2		
		OSM (mm)	600	750	900	1000	1200	1500	1800	2100	2200	2400		
Height	6 3/4	170	5 7/8	150	●	●	●							
	12 5/8	320	11 3/4	300		●	●	●	●	●	●			
	16 1/2	420	15 3/4	400	●									
	18 1/2	470	17 3/4	450		●	●	●	●	●	●	●	●	●
	20 1/2	520	19 3/4	500	●	●	●	●	●	●	●			
	24 3/8	620	23 5/8	600	●	●	●	●	●	●	●	●		
	32 1/4	820	35 3/8	800	●	●	●	●	●	●	●	●	●	●
	36 1/4	920	35 3/8	900	●	●	●	●	●	●	●	●	●	●
	40 1/8	1020	39 3/8	1000	●	●	●	●	●	●	●	●	●	●
	48	1220	47 1/4	1200	●	●	●	●	●	●	●	●		●
	59 7/8	1520	59	1500	●	●	●	●	●	●	●	●		
	71 5/8	1820	70 7/8	1800	●	●	●	●	●	●	●			
	83 1/2	2120	82 3/4	2100	●	●	●	●	●	●	●			
	95 1/4	2420	94 1/2	2400	●	●	●	●	●	●	●			

Partial Segmental and Extended Partial Segmental

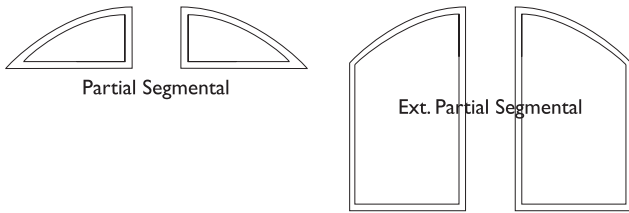

		Width														
		RO (Inches)	12 5/8	15 1/2	18 1/2	20 1/2	24 3/8	30 3/8	36 1/4	40 1/8	42 1/8	48	48 5/8	59 7/8	71 5/8	83 1/2
		RO (mm)	320	395	470	520	620	770	920	1020	1070	1220	1234	1520	1820	2120
		OSM (Inches)	11 3/4	14 3/4	17 3/4	19 3/4	23 5/8	29 1/2	35 3/8	39 3/8	41 3/8	47 1/4	47 3/4	59	70 7/8	82 3/4
		OSM (mm)	300	375	450	500	600	750	900	1000	1050	1200	1214	1500	1800	2100
Height	12 5/8	320	11 3/4	300		●	●	●								
	16 1/2	420	15 3/4	400	●											
	18 1/2	470	17 3/4	450		●	●	●	●	●	●	●				
	20 1/2	520	19 3/4	500	●	●	●	●	●	●	●					
	24 3/8	620	23 5/8	600	●	●	●	●	●	●	●					
	32 1/4	820	31 1/2	800	●	●	●	●	●	●	●	●	●	●	●	●
	36 1/4	920	35 3/8	900	●	●	●	●	●	●	●	●	●	●	●	●
	40 1/8	1020	39 3/8	1000	●	●	●	●	●	●	●	●	●	●	●	●
	48	1220	47 1/4	1200	●	●	●	●	●	●	●	●	●	●	●	●
	53 7/8	1370	53 1/8	1350	●	●	●	●	●	●	●	●	●	●	●	●
	59 7/8	1520	59	1500	●	●	●	●	●	●	●	●	●	●	●	●
	65 3/4	1670	65	1650	●	●	●	●	●	●	●	●	●	●	●	●
	71 5/8	1820	70 7/8	1800	●	●	●	●	●	●	●	●	●	●	●	●
	83 1/2	2120	82 3/4	2100	●	●	●	●	●	●	●	●	●	●	●	●
	95 1/4	2420	94 1/2	2400	●	●	●	●	●	●	●	●	●	●	●	●
	107 1/8	2720	106 1/4	2700				●	●	●	●	●	●	●	●	●

Round and Oval

- Available Standard Size for Round
- Available Standard Size for Oval and 3-Lite Extended Segmental

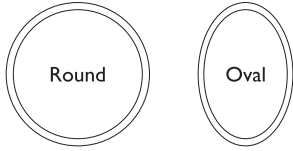

		Width									
Height	RO (Inches)	24 3/8	28 3/8	30 3/8	32 1/4	36 1/4	38 1/4	40 1/8	48		
	RO (mm)	620	720	770	820	920	970	1020	1220		
	OSM (Inches)	23 5/8	35 3/8	29 1/2	35 3/8	35 3/8	37 3/8	39 3/8	47 1/4		
	OSM (mm)	600	700	750	800	900	950	1000	1200		
24 3/8	620	23 5/8	600	•							
30 3/8	770	29 1/2	750			•					
36 1/4	920	35 3/8	900	•							
38 1/4	970	37 3/8	950					•			
48	1220	47 1/4	1200		•		•	•			•
59 7/8	1520	59	1500						•		

3-Lite Extended Segmental

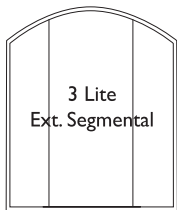

		Width									
Height	RO (Inches)	36 1/4	40 1/8	48	59 7/8	71 5/8	83 1/2	95 1/4	107 1/8	118 7/8	
	RO (mm)	920	1020	1220	1520	1820	2120	2420	2720	3020	
	OSM (Inches)	35 3/8	39 3/8	47 1/4	59	70 7/8	82 3/4	94 1/2	106 1/4	118 1/8	
	OSM (mm)	900	1000	1200	1500	1800	2100	2400	2700	3000	
18 1/2	470	17 3/4	450			•	•				
20 1/2	520	19 3/4	500		•	•	•				
24 3/8	620	23 5/8	600	•	•	•	•	•	•	•	•
32 1/4	820	31 1/2	800	•	•	•	•	•	•	•	•
36 1/4	920	35 3/8	900	•	•	•	•	•	•	•	•
40 1/8	1020	39 3/8	1000	•	•	•	•	•	•	•	•
48	1220	47 1/4	1200	•	•	•	•	•	•	•	•
59 7/8	1520	59	1500	•	•	•	•	•	•	•	•
71 5/8	1820	70 7/8	1800	•	•	•	•	•	•	•	
83 1/2	2120	82 3/4	2100			•	•	•			
95 1/4	2420	94 1/2	2400			•	•				



Triangle Rakes and Inverted Triangle Rakes

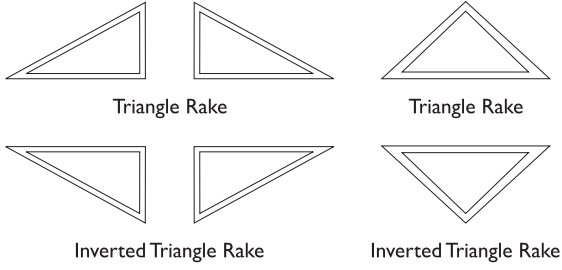

Trapezoid Rakes and Inverted Trapezoid Rakes

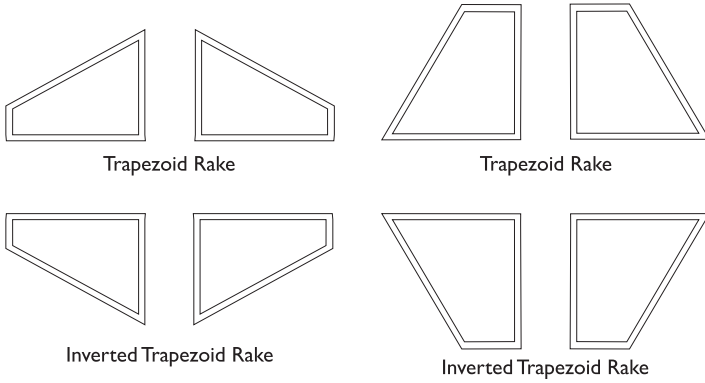

Peaked Rakes and Inverted Peaked Rakes

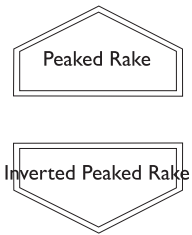

Flat Top Rakes and Inverted Flat Top Rakes

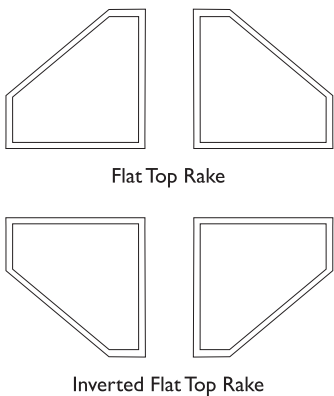



Diamond, Octagon and Hexagon

